

E3942
2/10/2020



The Signature of Quality®

SN4HD & SN6HD

Hot Deli Displays

INSTALLATION & OPERATION INSTRUCTIONS



KEEP THIS MANUAL FOR FUTURE REFERENCE

Engineering and technical data are subject to change without notice

FEDERAL INDUSTRIES
Toll Free 1(800)356-4206

215 Federal Avenue
WI Phone (608)424-3331

Belleville, WI 53508
Fax: (608)424-3234

Contents

INTRODUCTION	3
WARNING LABELS & SAFETY INSTRUCTIONS	4
PRE-INSTALLATION PROCEDURES	5
INSPECTION FOR SHIPPING DAMAGE.....	5
INSTALLATION INSTRUCTIONS	5-6
REMOVING CASE FROM SHIPPING SKID.....	5
REMOVING PACKAGING MATERIAL.....	5
LEVELING THE CASE.....	5
GRILL REMOVAL.....	6
PLUMBING CONNECTIONS.....	6
DISPLAY COMPONENT CHECK.....	6
CLEANING.....	6
ELECTRICAL INFORMATION & GROUNDING	7
OPERATING INSTRUCTIONS	8
INITIAL START-UP.....	8
OPERATING GUIDELINES.....	8
OPERATION OF WELLS.....	8
TEMPERATURE CONTROL ADJUSTMENT.....	9
REAR WRAPPING BOARD.....	9
LIGHT REPLACEMENT.....	9
DOORS.....	9
HINGED FRONT GLASS.....	10
PLACING PRODUCT INTO CASE.....	11
UNIT SHUTDOWN.....	11
CLEANING INSTRUCTIONS	12
SERVICE INFORMATION	13
PRE-SERVICE CHECKLIST.....	14
SPECIAL SERVICE SITUATIONS.....	15
SALE & DISPOSAL	15
OWNER RESPONSIBILITY.....	15
ELECTRICAL DATA	16
REPLACEMENT PARTS	17
WIRING DIAGRAM- SN4HD	18
WIRING DIAGRAM- SN6HD	19

INTRODUCTION

Thank you for purchasing a Federal Industries display case. This manual contains important instructions for installing and servicing the Series '90 Hot Deli Cases. A repair parts list and wiring diagram are also included in this manual. Read all of these documents carefully before installing or servicing your case.



NOTICE

Read this manual before installing your case. Keep this manual and refer to it before doing any service on the equipment. Failure to do so could result in personal injury or damage to the case.



NOTICE

Installation and service of the electrical components in the case must be performed by a licensed electrician.

The portions of this manual covering electrical components contain technical instructions intended only for persons qualified to perform electrical work.



DANGER

Improper or faulty hookup of electrical components in the case can result in severe injury or death.

All electrical wiring hookups must be done in accordance with all applicable local, regional, or national standards.

REGISTRATION & SERIAL NUMBER

It's important to keep a record of the model and serial number of your merchandiser for warranty and part identification. Please write them here for your quick reference.

Register your product online! Visit our website at www.federalindustries.com and register your product today.

Case Model _____ Serial Number _____

We're here to provide you with the best possible experience with your new product, however, we cannot cover everything about your merchandiser in this manual, so if you have any additional questions or issues, please see the SERVICE INFORMATION PAGE to find who you should contact.



This label is located on the back of the display case.

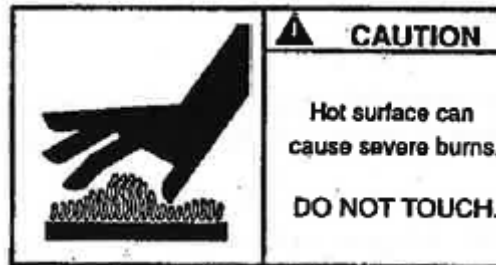

This label is located on the back of the display case.

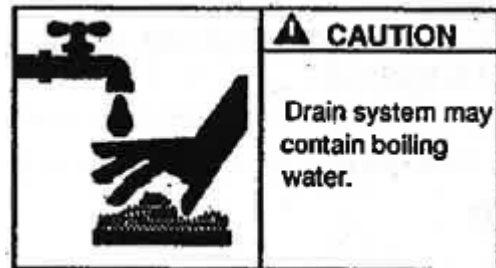

This label is located below the control panel on the back of the display case.

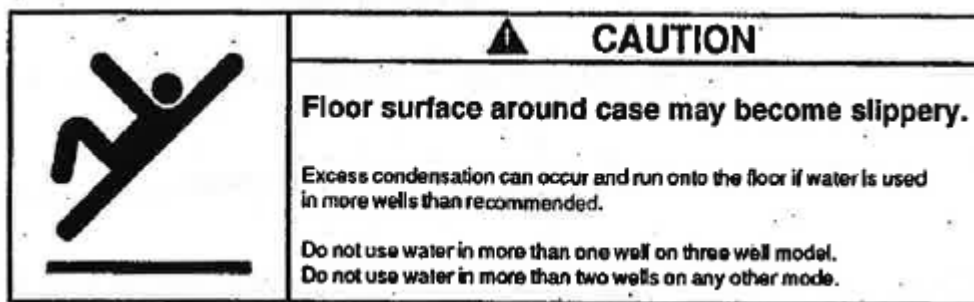

This label is located on the back of the display case.

PRE-INSTALLATION PROCEDURES

Inspection for Shipping Damage

You are responsible for filing all freight claims with the delivering truck line. Inspect all cartons and crates for damage as soon as they arrive. If damage is noted to shipping crates or cartons or if a shortage is found, not this on the bill of lading (all copies) prior to signing.

If damage is discovered when the case is uncrated, immediately call the delivering truck line and follow up the call with a written report indicating concealed damage to your shipment. Ask for an immediate inspection of your concealed damage. Crating material must be retained to show the inspector from the truck line.

INSTALLATION INSTRUCTIONS

Removing Case from Shipping Skid

 **CAUTION:** Do not push against the curved glass, end glass, doors, or door frames when removing the case from the skid or moving the case. Case damage or glass breakage could result.

Move the case as near as possible to the final location before removing it from the shipping skid.

Remove the four (4) bolts that secure the case to the skid. Do not remove the shipping brackets from the case. The brackets are intended to be used as hand grips for locating the case. Remove the brackets when the case is in the final location.

Removing Packaging Material

Remove the brackets that held the case to the shipping skid. Remove the shipping tape that secures the doors and lift-up glass. If it is necessary to remove tape to residue from plastic materials, use cleaning compounds recommended in the cleaning section of this manual.

Remove the plastic ties holding the wire shelves and shelf brackets in place.

Leveling the Case

The case must be level for proper appearance and display of product. Four (4) leg levelers are provided for leveling the case.

It is recommended that the base be sealed to the floor using an NSF approved sealant.

Grill Removal



DANGER: Electrical shock hazard. Do not operate unit with panels removed.

The front of the case has a removable panel base to access the front leg levelers from inside the case. Normally it is not necessary to remove the panel to install the case. The panel must be in place for proper operation of the case.

The rear of the case has a removable base panel to allow access to the field wiring connection box. Remove the panel to make field wiring connections. The panel must be in place for proper operation of the case.

Plumbing Connections

The case is supplied with a 1/2" female NPT pipe coupling and a 1" male NPT drain fitting that can be used for a connection to a water source and drain. A pan filler spray hose is also provided. This spray hose has a 1/2" male NPT fitting for connection to a water supply. If the case is hooked to a water source, it is advisable to install a shut-off valve in the water supply line.

Plumbing connections do not have to be made up in order for the case to operate properly. The well(s) can be manually filled to the correct level and they can be drained with the use of a catch container.

Display Component Check

The case is supplied with incandescent lighting. The lights are mounted on the ceiling of the case. The control switch for the lights is located on the control panel on the back of the case. The lights should be turned off any time the case is not in operation.

The case is also equipped with a top mounted full-length infrared heater. The heater temperature control is on the control panel on the back of the case. The temperature control knob has an "off" position and numbered positions from 1 to 7 depending on the amount of heating required. There is a pilot indicator above the temperature control knob that lights when the knob is moved to a numbered position. After the case is properly wired to the power source, the temperature control knob should be moved to a numbered position to verify that the heater functions properly. The pilot light indicator will remain lit until the heater reaches the proper temperature. The heater temperature control knob should be in the "off" position any time the case is not in operation.

The case has separate temperature controls for each well in the control panel. The temperature control knobs have an "off" position and numbered positions from 1 to 10 depending upon the amount of heating required for each well. There is a pilot light indicator next to each temperature control knob that lights when the knob is moved to a numbered position. After the case is properly wired to the power source, each temperature control knob should be moved to a numbered position to verify each well is heating. This check should be performed on one well at a time. The pilot light indicator will remain lit until the well reaches proper temperature. The temperature control knobs should be in the "off" position when the case is not in use.

The case is provided with an air circulation fan to prevent condensation from forming on the front glass when water is used in the food wells. A switch is provided for the fan and is located on the control panel.

Cleaning

The case should be cleaned thoroughly before initial use.

For initial setup, clean the case as outlined in the cleaning section.

ELECTRICAL INFORMATION & GROUNDING

This Case Must Be Grounded



DANGER: Improper or faulty hookup of electrical components in the display case can result in severe injury or death.

All case electrical connections must be performed only by a licensed electrician.

All electrical wiring hookups must be done in accordance with all applicable local, regional, or national electrical standards.

A separate circuit for each display case is recommended to prevent other appliances on the same circuit from overloading the circuit and causing malfunction.

The electrical service must be grounded upon installation.

The case is designed for permanent connection to a power source. A 7/8" diameter hole is provided in the back of the case for field wiring connections. There is also an access hole in the case for running the power supply up through the floor. See diagram below.

The electrical connection box is accessible from the rear of the case. See diagram below for location of the field wiring connection box.

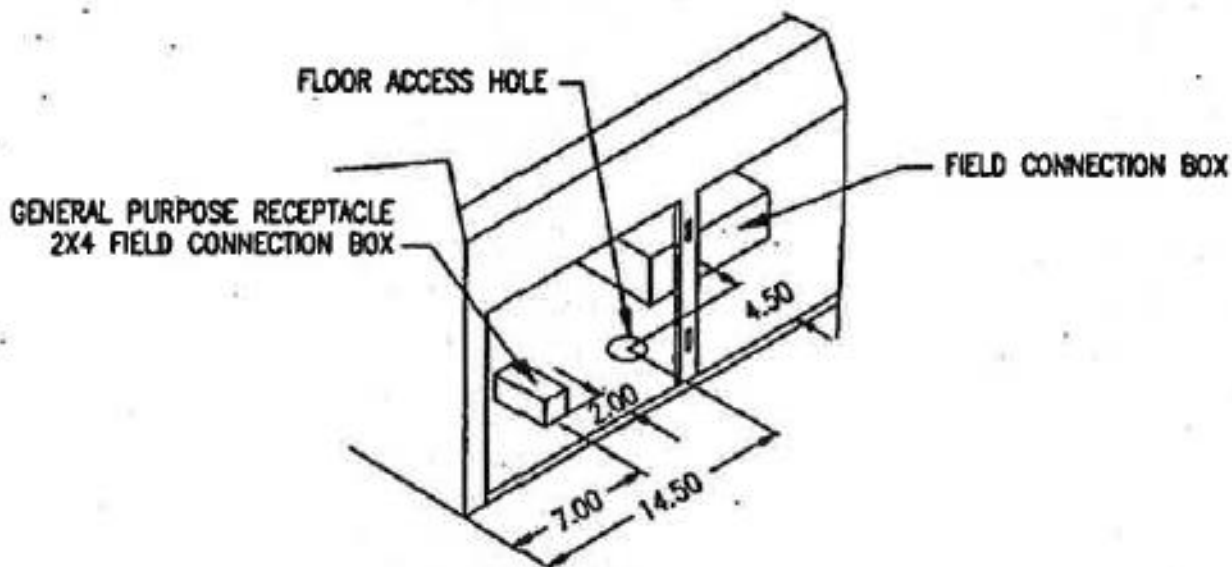

OPERATING INSTRUCTIONS

Initial Start-Up

After all the checks outlined in the installation section of this manual have been made, the case is ready to be put into service.

The case should be cleaned thoroughly before it is used for the first time.

Operating Guidelines



NOTICE: This case should not be operated with water in all the wells. Excess condensation can occur and run onto the floor creating a slip/fall hazard around the case.

In operation, do not use water in more than one well. Using water in more wells than recommend will cause excessive condensation that can run onto the floor and create a slip/fall hazard around the case.

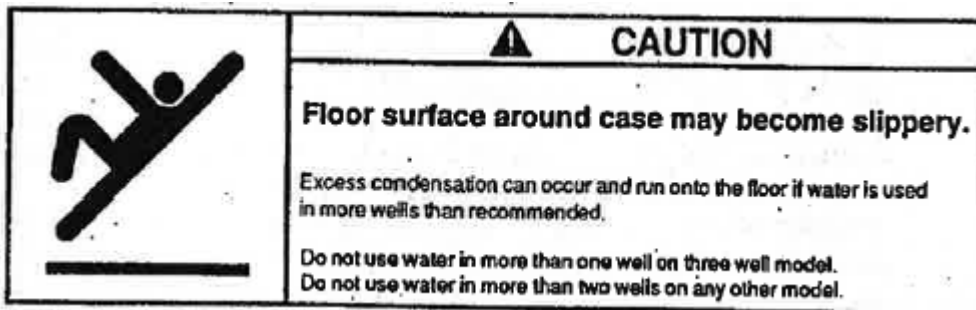

Operation of Wells

The case will keep many products at the proper temperature without the use of water. The type of food product being kept in the case is the determining factor as to whether water is used in the well. Any product that can be run dry should be held in a dry well to prevent excessive condensation from forming on the glass.



NOTICE: Never allow wet wells to boil

Never allow wet wells to boil. A water temperature for 180F to 190F is recommended. The water level in a wet well should always be high enough to touch the bottom of the pan holding the product.

The overhead infrared heater should be on when food product is being kept in the case. The heater helps to maintain proper product temperature and prevents front glass from fogging.



NOTICE: Never pour water into a heated, dry well.

Close the well drain valves located in the lower compartment for any well(s) to be run wet. Fill any well(s) to be run wet with three to four inches of water utilizing the plumbed water supply or fill manually. The water lever in a wet well should always be high enough to touch the bottom of the pan holding the product.

Temperature Control Adjustment

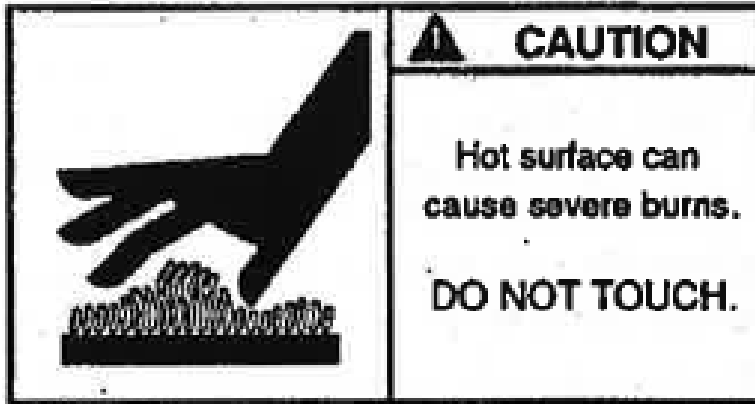

Each well has a separate temperature control. Turn the control to the appropriate numbered position for either wet or dry operation depending on the type of product stored. The temperature control should be set at the lowest possible number that will maintain proper product temperature. The pilot light will go off when the well(s) have reached a set temperature.

The infrared heater has a separate power switch and temperature control. Turn the temperature control to the lowest possible number that will maintain proper product temperature. The pilot light will go off when the heater reaches the set temperature.

Rear Wrapping Board

The rear wrapping board is attached to the back side of the case and can be put into position by swinging it up and pushing it forward. It can also be removed completely by lifting it upward off its mounting track while the wrapping board is in the down position.

Light Replacement

When replacing lights, use direct equivalents to the original bulbs.

Doors

The doors can be removed by lifting the door up until the bottom clears the lower door track.

Clean the door track frequently for easy door operation. A very light film of lubricant, such as PAM, will help the doors slide easily

Hinged Front Glass

The front glass hinges up for easy cleaning of the case interior. Pneumatic cylinders assist in lifting the glass. The glass will hold in any position beyond approximately the first 20" of travel. In the first 20" of travel, the glass will gently close. See diagram below:

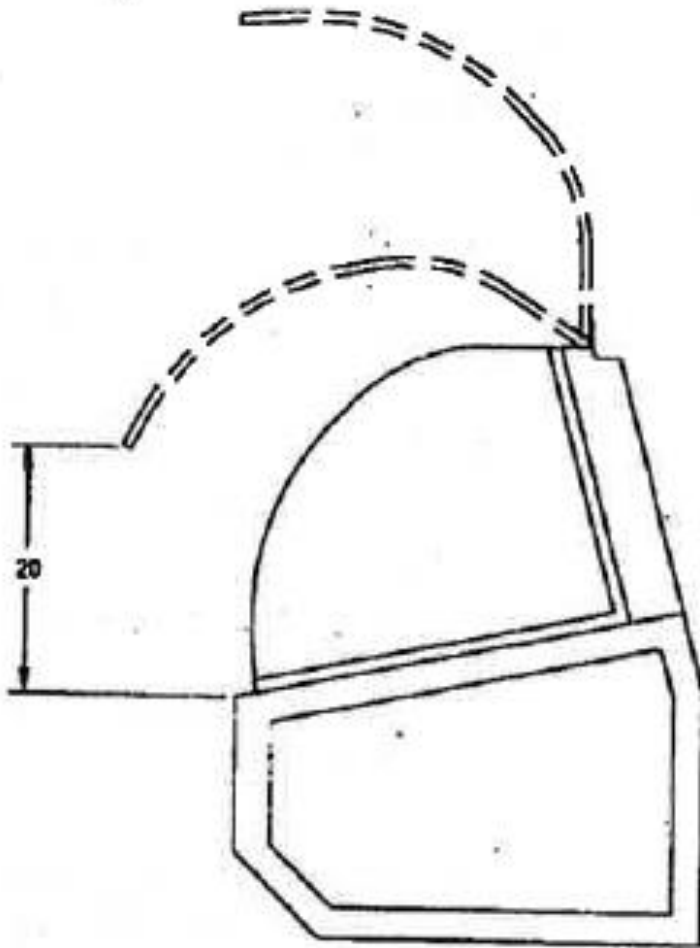

The hinged glass mechanism will give years of reliable operation in normal usage. Service on the lift mechanism is required if...

- The glass becomes difficult to open.
- The glass does not hold in the open position.
- The glass closes fast.

Consult the factory if service is required.

CAUTION:



OPERATION OF THE LIFT-UP GLASS IS TO BE DONE BY TRAINED STORE PERSONNEL ONLY. THIS CASE IS NOT INTENDED TO BE USED AS A SELF SERVE UNIT. DO NOT ALLOW CUSTOMERS TO OPERATE LIFT- UP GLASS.

Placing Product Into Case



Place the deli pans containing the product into the preheated wells.

**NOTE: Always preheat the wells before placing the product into the case to assure the product will maintain the proper temperature. Freshly cooked product should never be added to the display with a probed temperature of less than 170F. if you are using a wet well make sure that the bottom of the deli pan containing the product touches the preheated water in the well.*

 **NOTICE:** Never allow wet wells to boil.

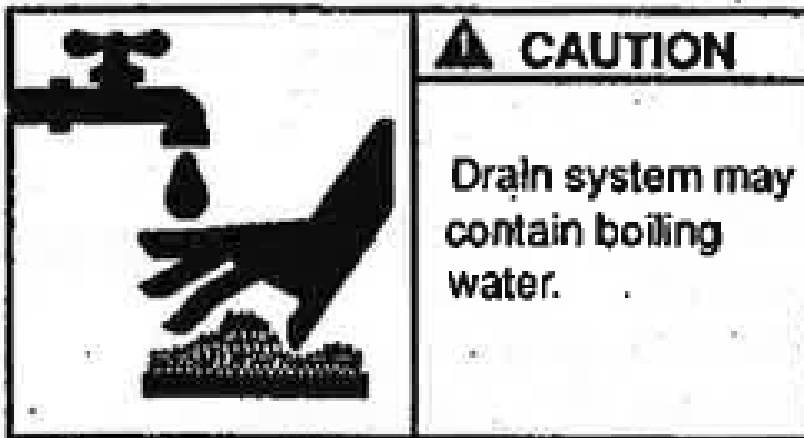

Unit Shutdown

Remove all deli pans containing product from the case. Turn off heat to the wells by turning the temperature control knobs to the "OFF" position. Turn the infrared heater off by turn the temperature control knob to the "OFF" position. Turn off the lights. Turn off the case power switch. It is recommended that any water in the wells be allowed to cool before draining. The wells should be flushed with a generous amount of water to remove any residue.

 **WARNING:** If water is to be drained while hot, extreme care should be taken to avoid burns from hot water.

CLEANING INSTRUCTIONS

The case should be cleaned thoroughly before it is used for the first time.



NOTICE: Avoid Splashing or soaking any electrical components with water to prevent electrical damage to the case.



NOTICE: Shut off lights and power switches and remove all product from the case. Allow sufficient time for the unit to reach room temperature before proceeding with cleaning.

Cleaning Door Tracks

The rear doors may be removed for cleaning by lifting the door upward until the bottom clears the lower door track and then outward.

Clean all foreign material from the door tracks daily. Buildup of crumbs may make doors slide hard. A light film of lubricant, such as PAM, can be applied to the tracks to make the doors slide easier.

Cleaning the Case Interior

Turn off the well heaters, infrared heater and lights. Turn case power switch off.



CAUTION: Allow the wells and infrared heater to cool before cleaning.

Clean the case interior with warm soapy water. Mild cleansers and plastic scouring pads may be used to remove baked on food and water scale.

Cleaning Case Exterior

The glass can be cleaned with common window cleansers.

Plastic exterior surfaces can be cleaned with any ammoniated household cleaner. Stains can be removed by scrubbing with TRIAENE Soap, ETHYL CELLOSOLVE, CARBONA, or similar solvent based cleaning fluids. The surfaces must be thoroughly rinsed with water after using solvent based cleaners.

SERVICE INFORMATION

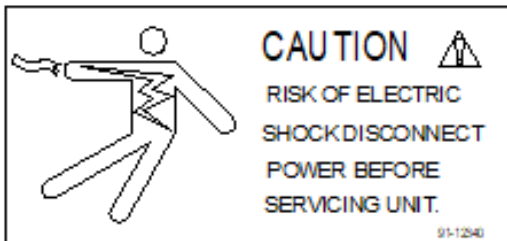

Before any service work is performed on the case, make sure all power is disconnected to the case.

To find a service company in your area, please visit our website at www.federalindustries.com. There you can also find self-service tools to help you get the answers you need faster!

For Warranty Service Requests & ALL Technical Support please contact:

- **Phone:** (800) 356-4206 and choose the Tech Support/Warranty Option
- **Email:** Service@federalind.com

For Warranty Compressors please contact the Parts Department:

- **Phone:** (800) 356-4206 and choose the Warranty Parts Option
- **Email:** Parts@Federalind.com



Federal Industries has partnered with Parts Town for ALL Non-Warranty Part Identification, Pricing, Lead Times, Orders & Freight Quotes. Please contact Parts Town directly if you need parts:

- **Website:** PartsTown.com
- **Email:** CustomerService@PartsTown.com
- **Phone:** 833-809-8188

Pre-Service Checklist

You may avoid the cost and inconvenience of an unnecessary service call by first reviewing this checklist of frequently encountered situations that can cause unsatisfactory case performance.



CAUTION: Before servicing the case turn off power at the main breaker or fuse box.

1. Case Does Not Operate

- a.** Check for disconnected power supply.
- b.** Check for tripped breaker or blown fuse.
- c.** Check that the temperature controls are “on”.

2. Lights Do Not Operate

- a.** Check that the light switch is “on”.
- b.** Check that bulbs are properly seated in the sockets.

3. Glass Fogging

- a.** Check room ambient- Case is designed to operate in an environment not to exceed 75F and 55% relative humidity.
- b.** Check that nothing is blocking the front air vents.
- c.** Check that the blower switch is “on”.
- d.** Check that air is being blown evenly across the front glass surface. If the air is not blowing or is not blown evenly, service is required.

Special Service Situations

If moisture or liquid is observed around or under a Federal Industries case, an immediate investigation should be made by qualified personnel to determine the source of the moisture or liquid. The investigation made should determine if the case is malfunctioning or if there is a simple housekeeping problem.

Moisture or liquid around or under a case is a potential slip/fall hazard for persons walking by or working in the general area of the case.

Any case malfunction or housekeeping problem that creates a slip/fall hazard around or under a case should be corrected immediately.

SALE & DISPOSAL

Owner Responsibility

If you sell or give away your Federal Industries case you must make sure that all safety labels and the Installation- Service Manual are included with it. If you need replacement labels or manuals, Federal Industries will provide them free of charge. Contact the customer service department at Federal Industries at (800)356-4206.

The customer service department at Federal Industries should be contacted at the time of sale or disposal of your case so records may be kept of its new location.

ELECTRICAL DATA

120/208-240 Volt/ 60HZ/ 1PH

<u>Model</u>	<u>Total Amps</u>
SN4HD	30Amps
SN6HD	45Amps

The case must be wired to a 208 through 240 VAC, single phase, three wire electrical source. Only copper wire can be used for the power supply connections.

Incoming wire size requirements for the Series '90 Hot Deli Models are as follows:

<u>Models:</u>	
SN4HD	#10AWG Copper Wire
SN6HD	#8AWG Copper Wire

The case must also be wired to a 115 VAC, single phase, three wire electrical source for the general purpose receptacle.

Units are intended for permanent field connection only. Electrical installation must be in accordance with all national, state, and local electrical codes, and must be performed by qualified electrical personnel.

Models are equipped with a general purpose receptacle requiring separate electrical circuit installed in accordance with National Electrical Code.

General Purpose Receptacle

<u>Model</u>	
SN4HD	115VAC, 15Amps
SN6HD	115VAC, 15Amps

REPLACEMENT PARTS

MODELS SN4HD & SN6HD

Part Description	Model	
	<u>SN4HD</u>	<u>SN6HD</u>
<u>Heating System</u>		
Infrared Heating Unit	47-11340	47-11341
Replacement Heating Well	47-12081	47-12081
Center Heating Well	N/A	47-12082
 <u>Electrical Components</u>		
Fan Rocker Switch	41-11066	41-11066
Light Toggle Switch	41-11569	41-11569
Fuse Holder	41-30513	41-30513
Fuse	41-10713	41-10713
Terminal Block	45-11308	45-11308
GFCI Receptacle	45-18315	45-18315
Blower	41-32512	41-32512
Infinite Control	41-11568	41-11568
Pilot Light	42-31607	42-31607
 <u>Misc. Components</u>		
Thermometer	41-34007	41-34007
Front Glass	51-10995	50-10998
Clear End Glass	50-11115	50-11115
Reflective End- L.H.	50-11173	50-11173
Reflective End- R.H.	50-11174	50-11174
Clear Rear Door	51-11345	51-11346
Reflective Rear Door	51-11347	51-11348
Glass Handle	66-11106	66-11109
Gas Cylinder	81-11046	81-11046
Pivot Hinge Glass	66-11076	66-11076
Leg Leveler	65-11486	65-11486
Decal- Electrical Hazard	91-10743	91-10743
Decal- Caution Hot	91-10207	91-10207
Label- Danger	91-10293	91-10293
Label- Caution Hot Surface	91-10936	91-10936
Label- Caution Slippery Floor	91-10956	91-10956
Label- Caution Drain System	91-10937	91-10937
Water Fill Hose Assembly	72-80008	72-80008

WIRING DIAGRAM- SN4HD

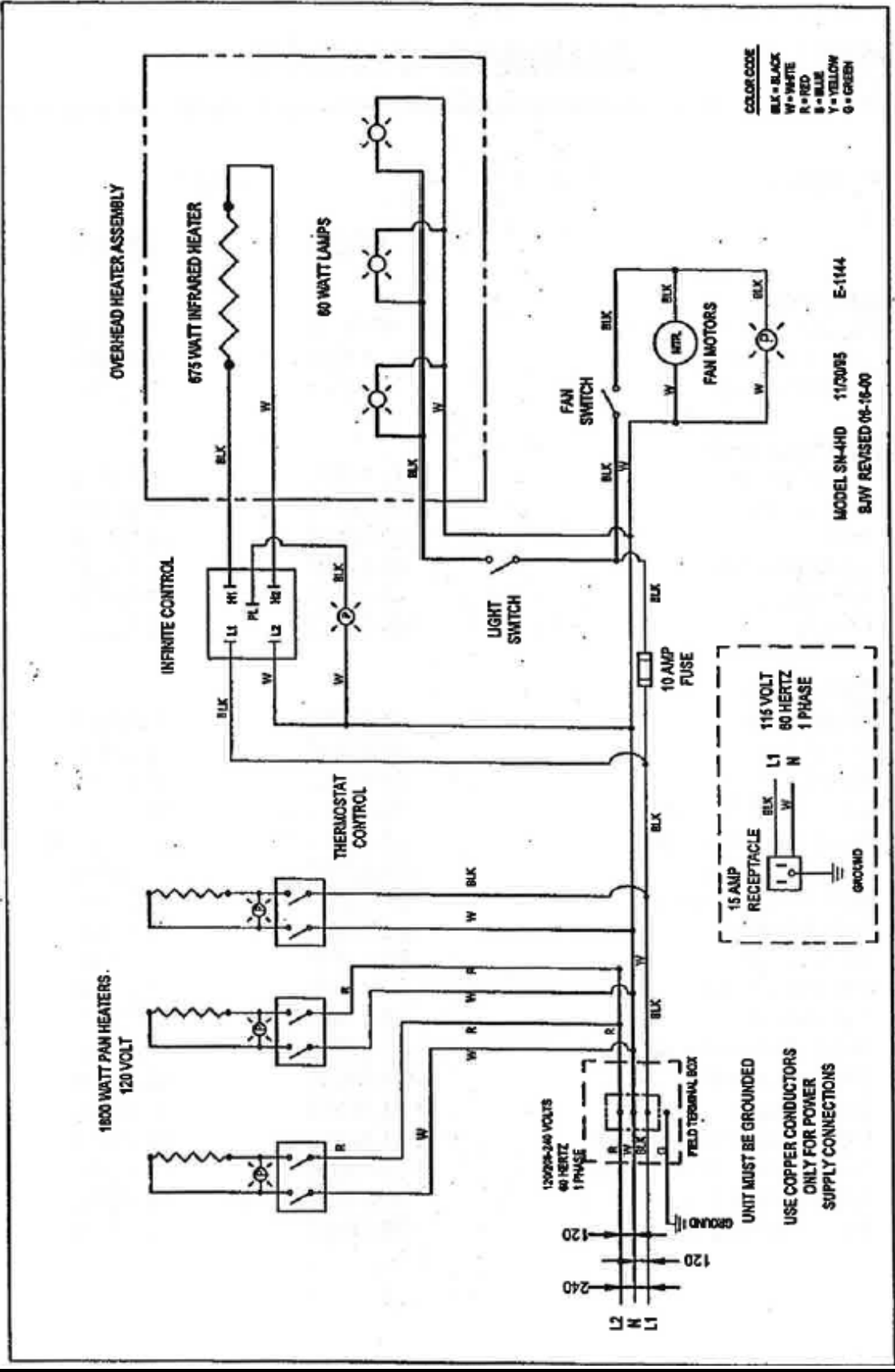

WIRING DIAGRAM- SN6HD

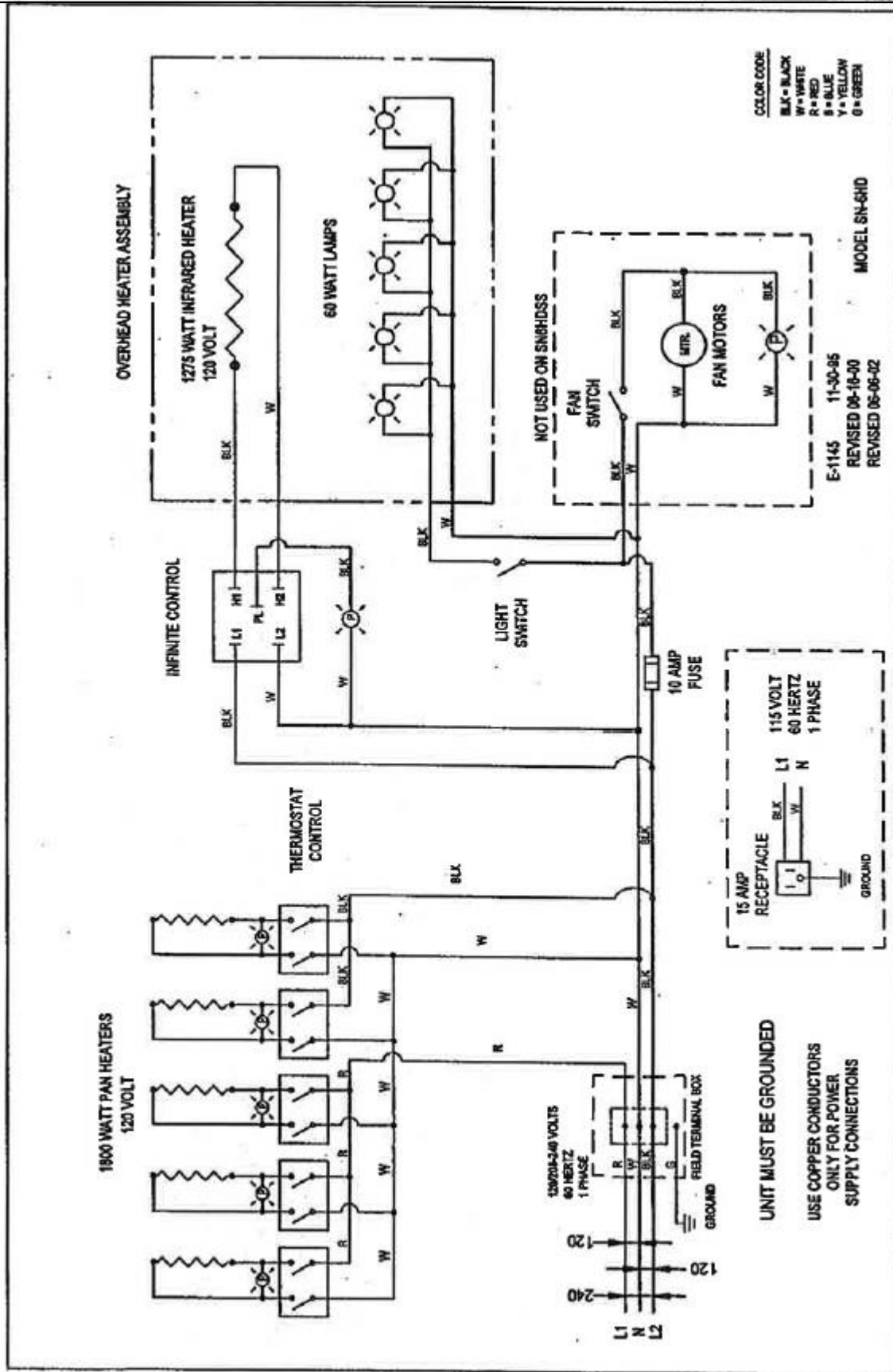

California Residents Only.

 **WARNING**

This product can expose you to chemicals including chromium which is known to the State of California to cause cancer and birth defects or other reproductive harm. For more information go to www.P65Warnings.ca.gov

